

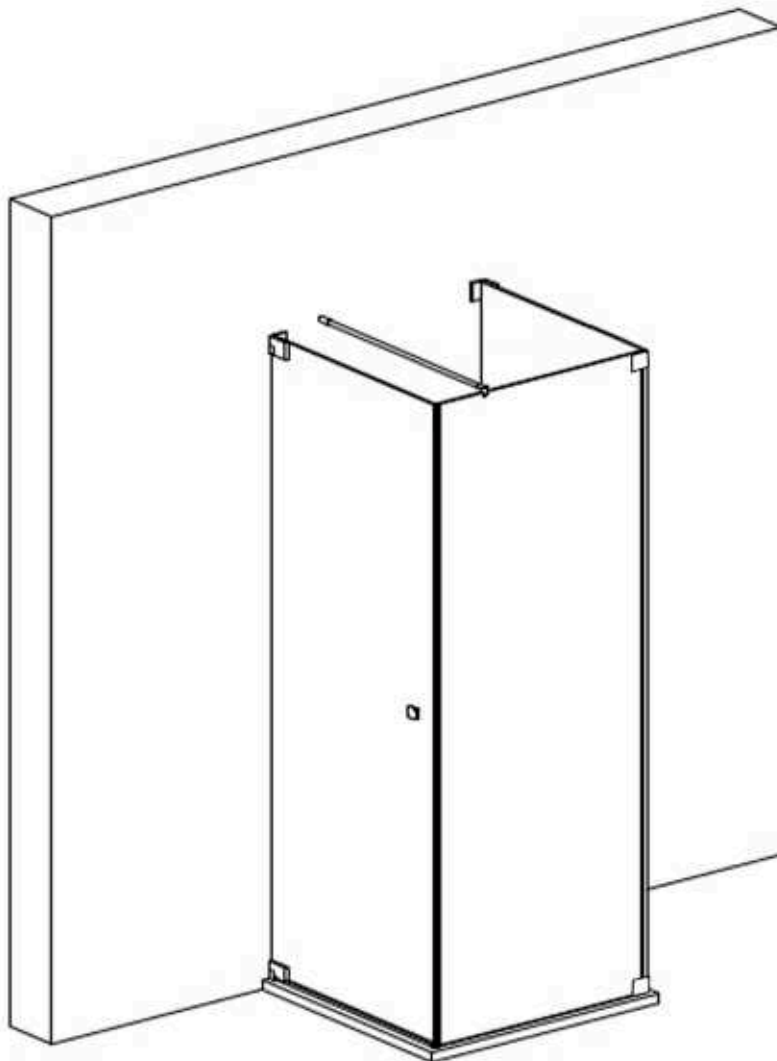

























Modell GU1W, HU1W, MGU1W

Montageanleitung
Installation Manual



3-Seiten U-Duschkabine
U-shaped shower enclosure
Links / Left

1 x G/WS-LO		1 x G2/G2H		8 x G100		8 x 	4 x C2	
1 x G/WS-LU		1 x G3/G3H		8 x G300		8 x 	1 x G/SUL120	
1 x G/FX-LU/RO		1 x G7/G7H		4 x G301		8 x 	2 x 	
1 x G/FX-LO/RU		1 x G9/G9H		2 x G302		1 x 		
2 x G/EL		1 x G10		1 x G400		1 x 		
		1 x G13/G13H				1 x G150		

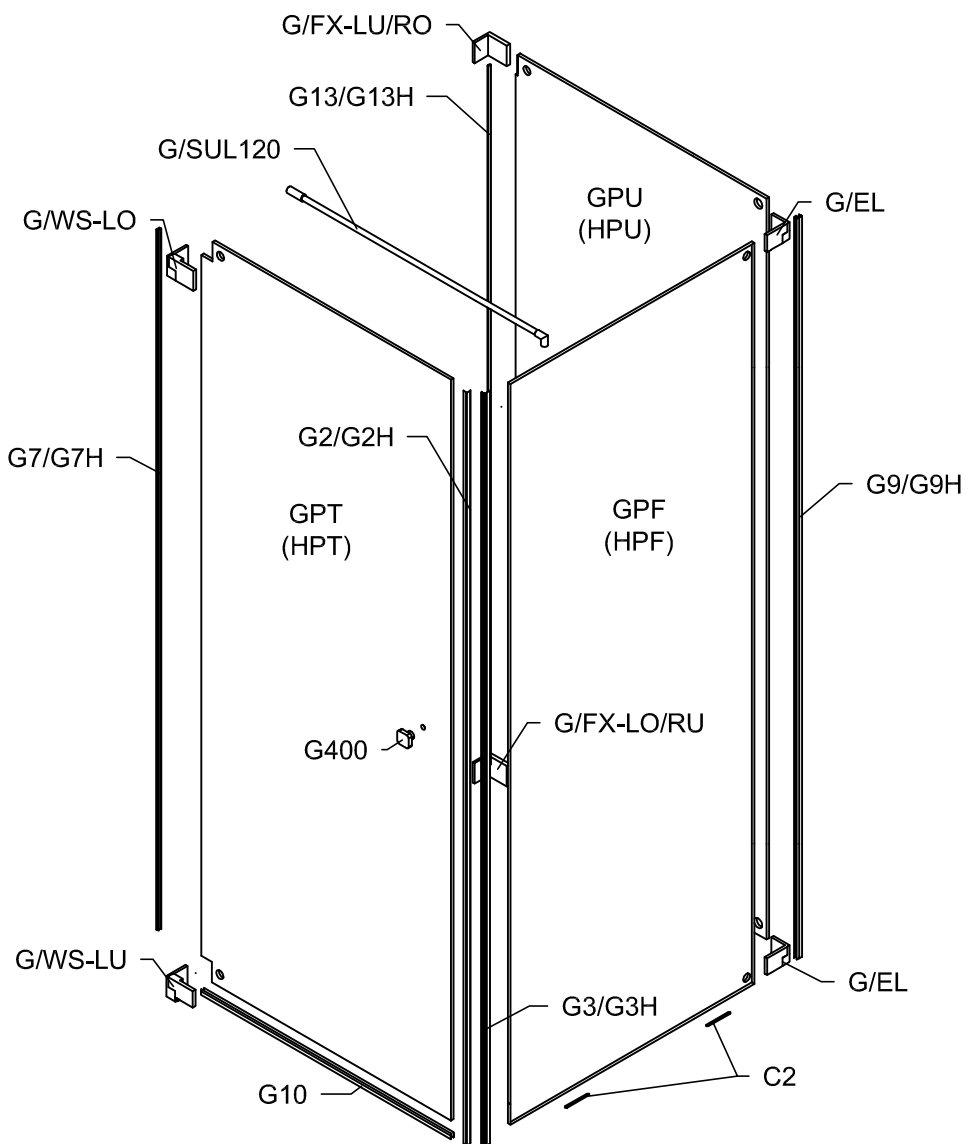

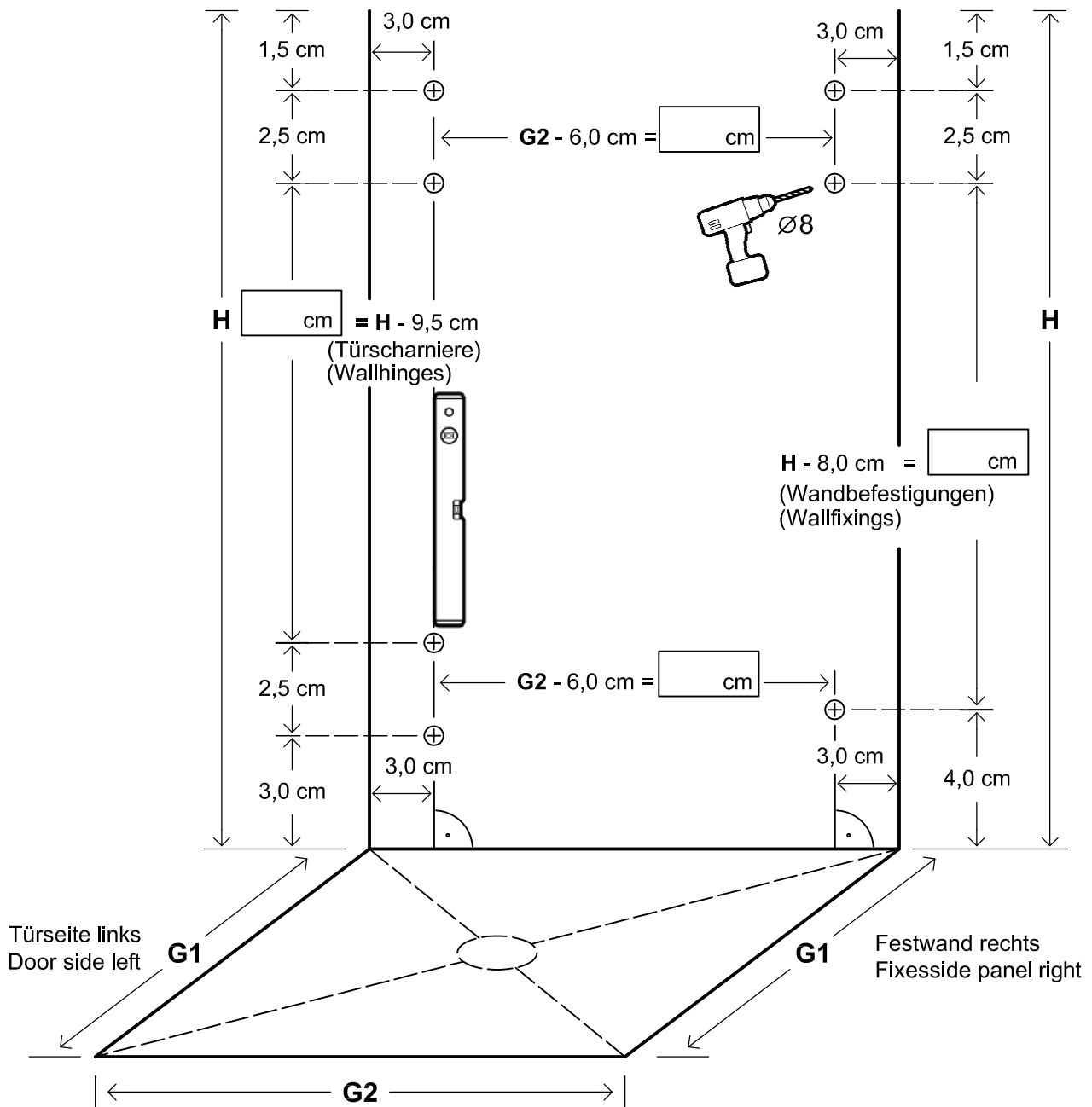

Diese Maße finden Sie in ihrem Auftrag:
You find this measures in your order:

H = Glas - Höhe
Glass height

G1, G2 = Glasaußenkante (unterer Wert des Verstellbereichs)
Outer edge of the glass (lower value of adjustment range)

Die Zeichnungen sind **nicht** Maßstabsgetreu.
The drawings are **not** to scale.

Vormontage von Dichtprofilen und Beschlägen Pre-assembly of gaskets and fittings.

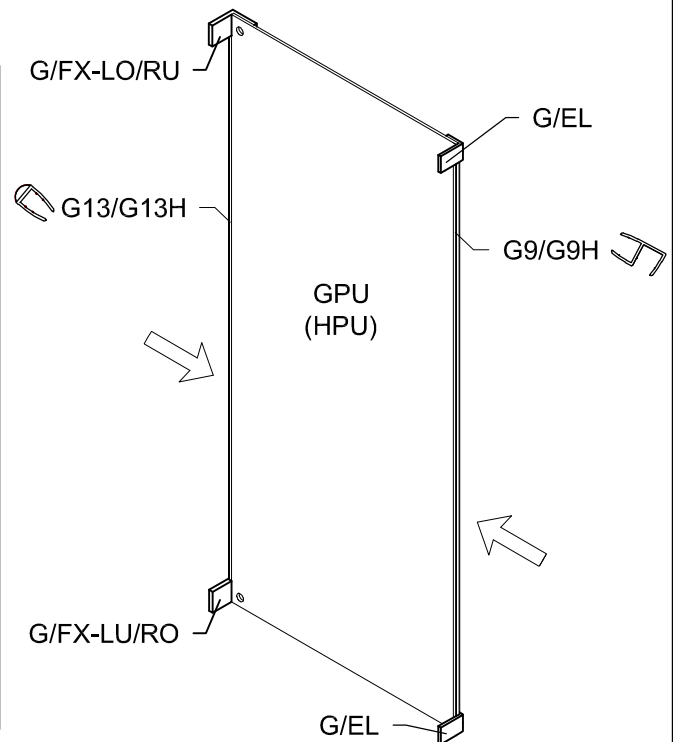
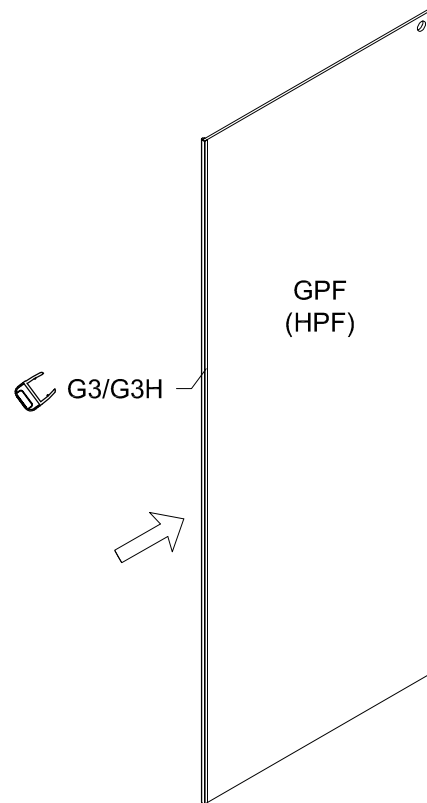
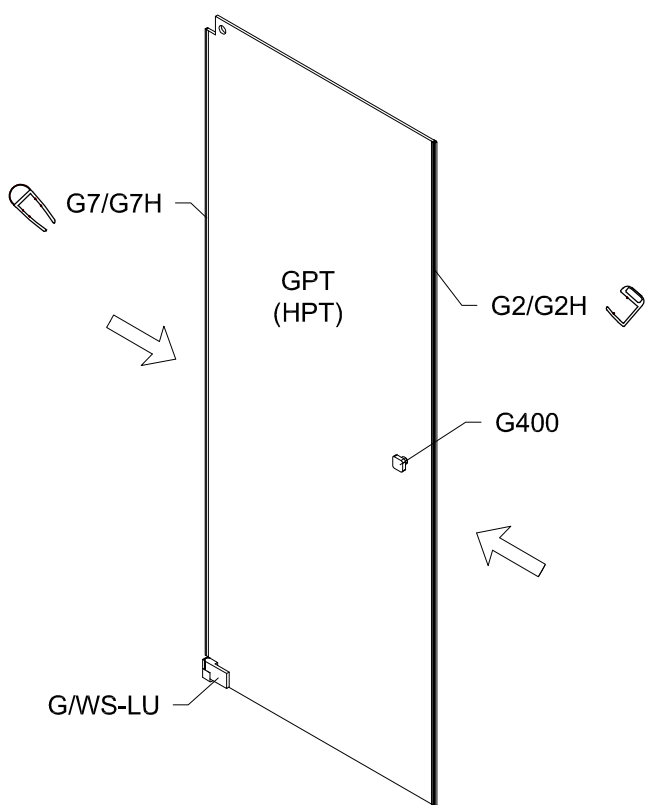

Bei gerader Wand kann auf das Kompensationsprofil G13/G13H verzichtet werden und der senkrechte Wandanschluss wird dann absilikoniert (Abstand Wand / Glas min. 3 mm).

A straight wall does not need the compensation gasket G13/G13H. In this case apply silicone caulking to the vertical connection (distance wall / glass min. 3 mm).

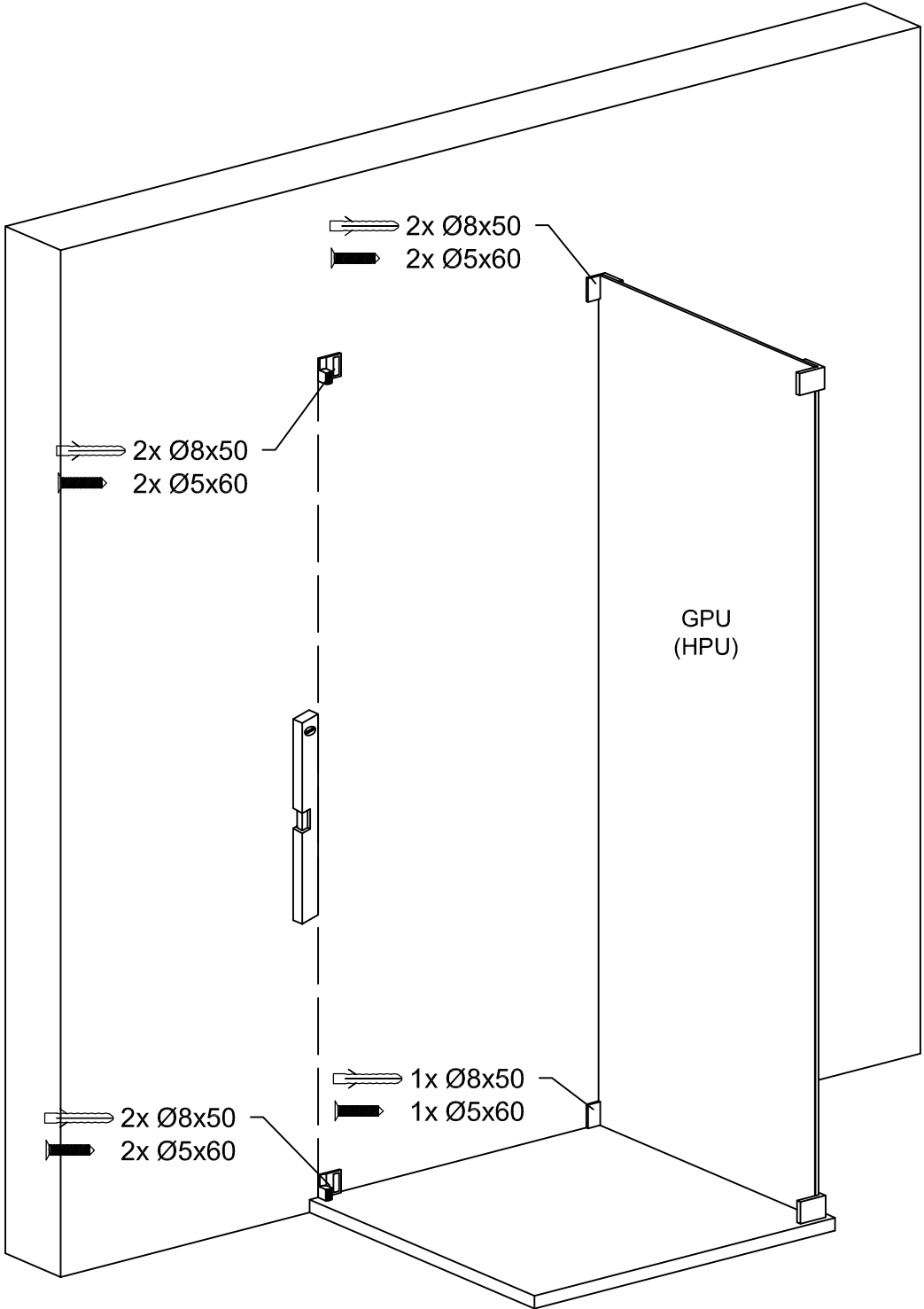

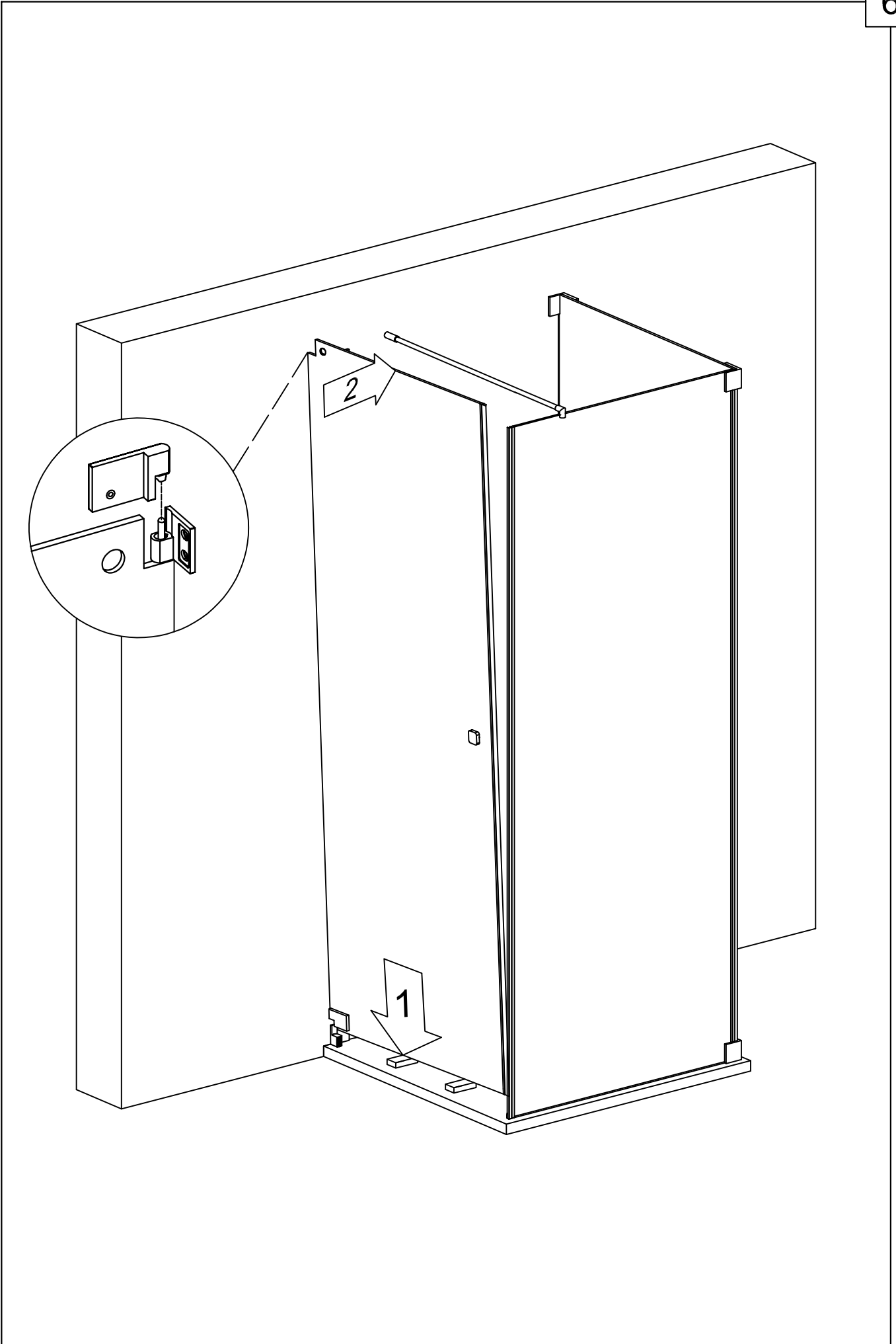

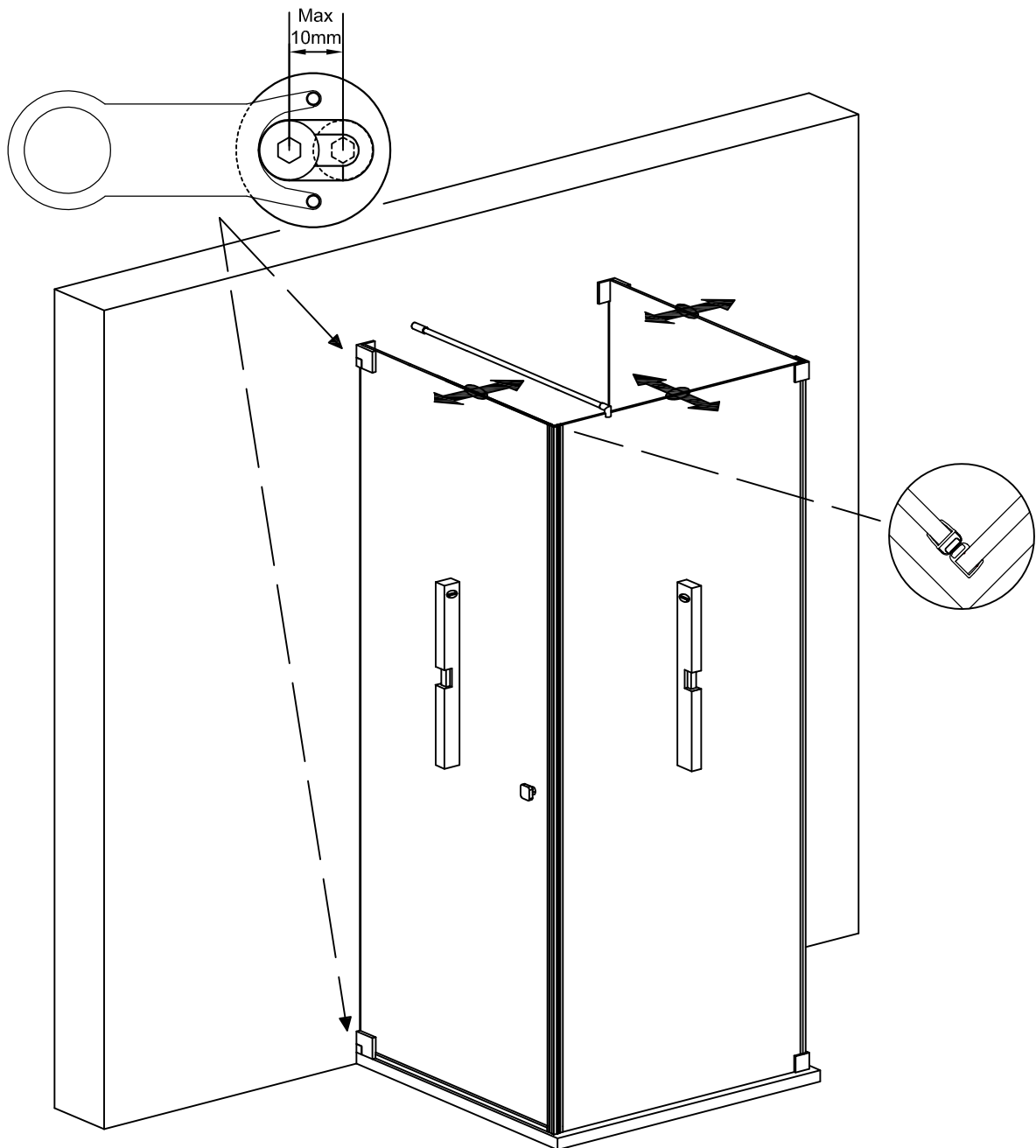

Richten Sie das Glas-Festteil senkrecht aus und fixieren sie die Inbus-Schrauben in den Langlöchern der Glasbefestigungen. Mit dem Montage-Schlüssel können die Glasbefestigungen dabei waagrecht gehalten werden. Schieben Sie dann das Kompensationsprofil (G13 / G13H) auf dem Glas-Festteil an die Wand, um Schrägen auszugleichen. Bei gerader Wand kann auf das Kompensationsprofil verzichtet werden und der senkrechte Wandanschluss absilikontiert werden (Abstand Wand / Glas min. 3 mm). Schieben Sie dann das Tür-Kompensationsprofil (G7 / G7H) auf der Glas-Türe an die Wand, so dass die Fuge zwischen Wand und Türe mit dem Balg leicht an der Wand anliegend gleichmäßig geschlossen wird.

Set up the fixed glass part vertically and fix the Inbus screws in the slotted holes of the glass fixings. By using the installation key the glass fixings can be kept horizontally. Slide the compensation gasket (G13 / G13H) with force on the fixed glass part against the wall to even out possible slopes. A straight wall does not need the compensation gasket. In this case apply silicone caulking to the vertical connection (distance wall / glass min. 3 mm). Slide the compensation gasket (G7 / G7H) on the glass door against the wall to close the gap between wall and door evenly with the bellows soft to the wall.

