

Modell PGPO, PHPO

Montageanleitung
Installation Manual

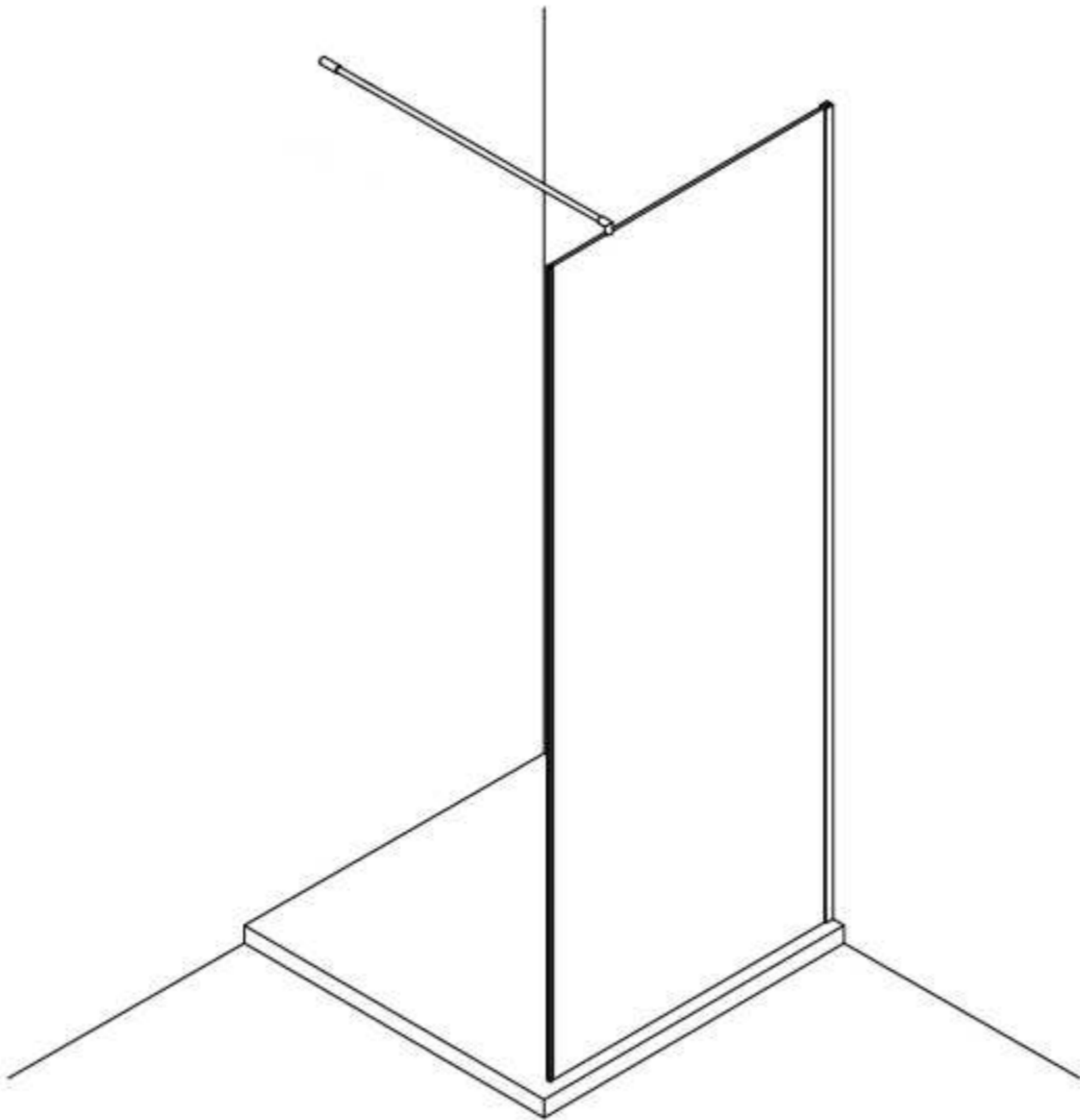

Eck-Dusche mit Festwand
Corner shower enclosure with fixed side panel
Rechts / Right

1 x P/WKP



1 x G/SUL120



4 x 5x60

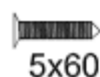

2 x C2



4 x d



4 x 8x50

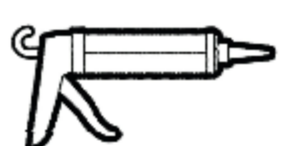
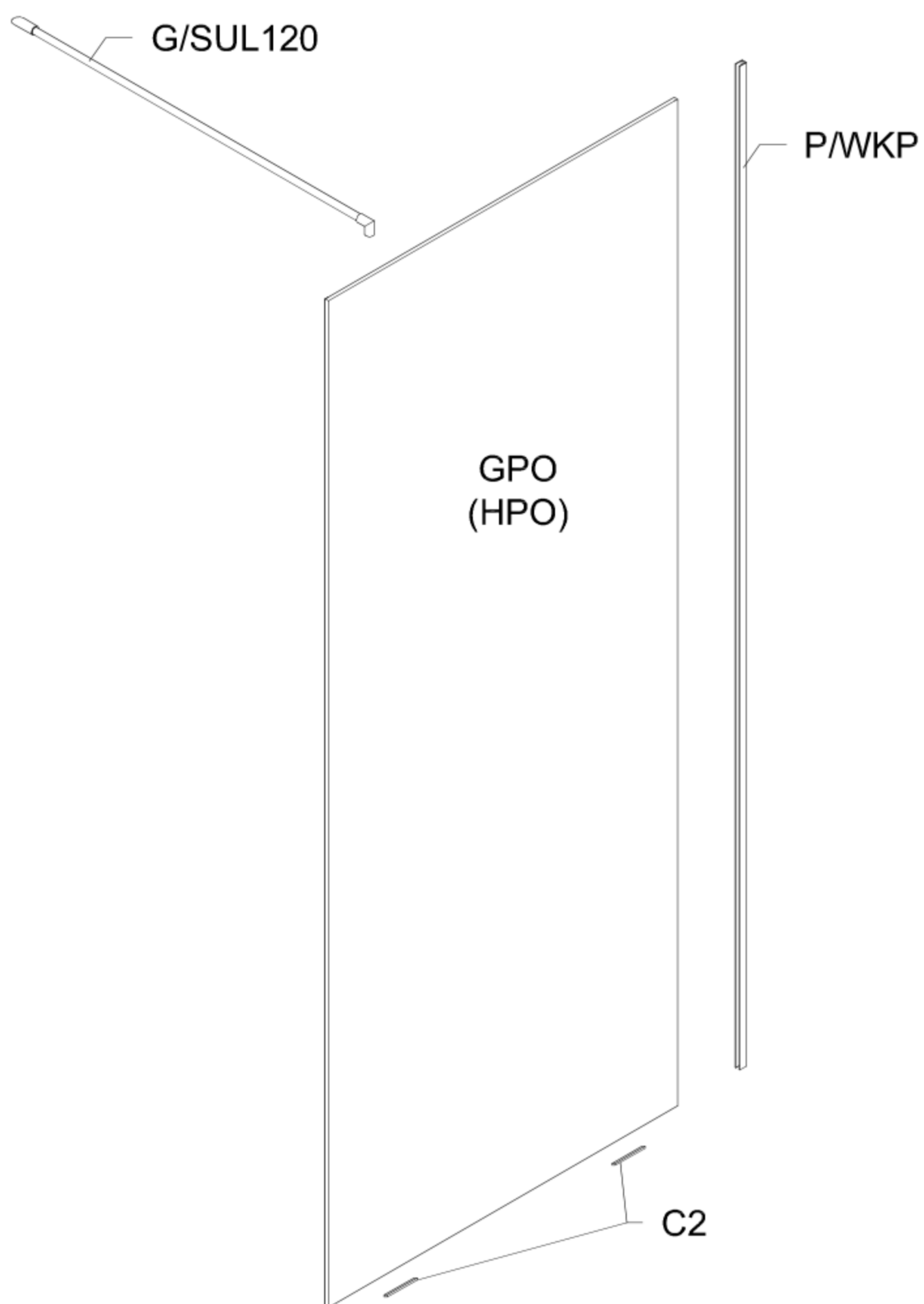
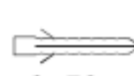

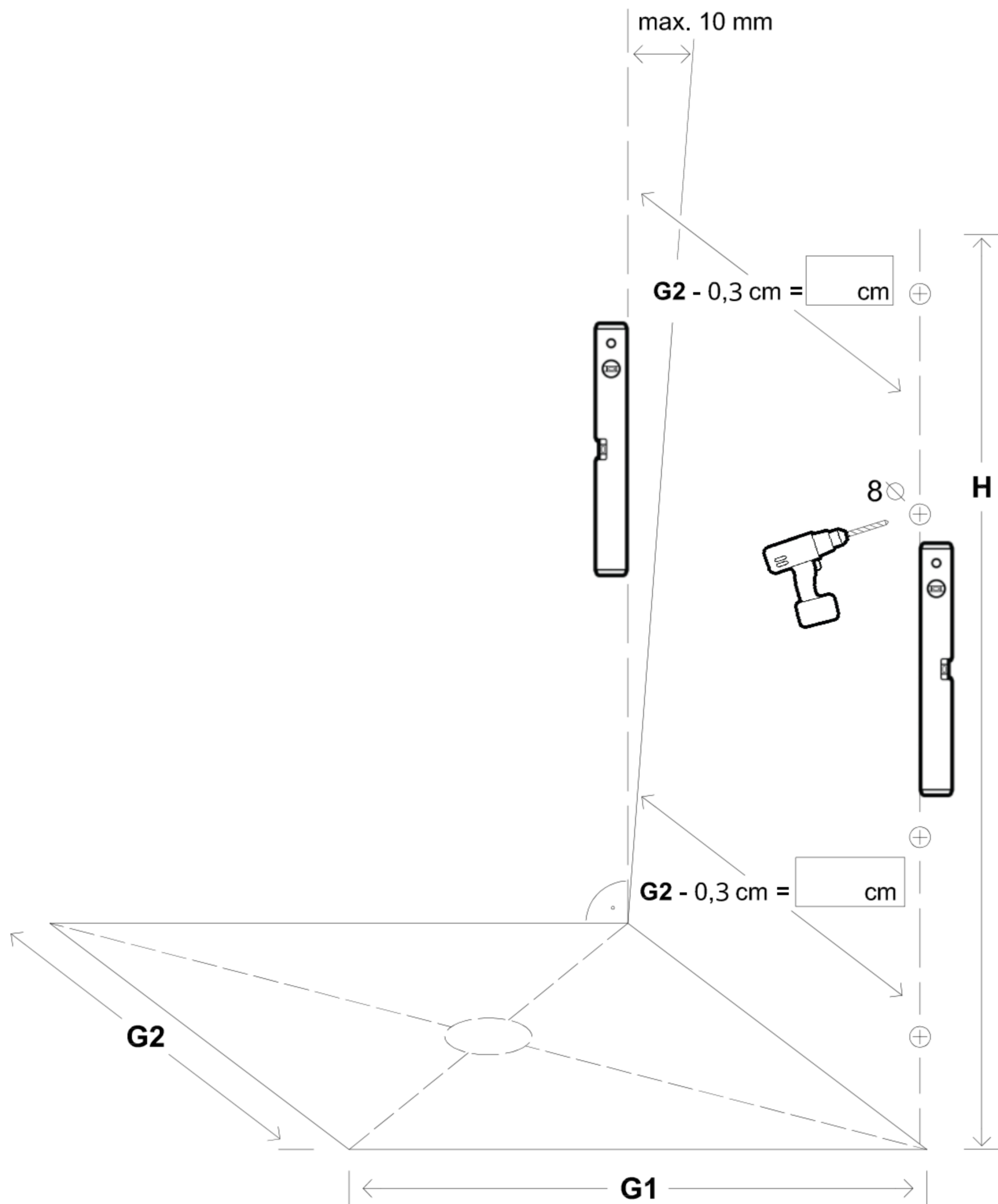

Benutzen Sie das Wandprofil zum Anzeichnen der Bohrlöcher.
Use the wall profile to mark the drill holes.

Diese Maße finden Sie in Ihrem Auftrag:
You find these measures in your order:

H = Glas - Höhe
Glass height

G1, G2 = Glasaußenkante (unterer Wert des Verstellbereichs)
Outer edge of the glass (lower value of adjustment range)

Die Zeichnungen sind **nicht** Maßstabsgetreu.
The drawings are **not** to scale.

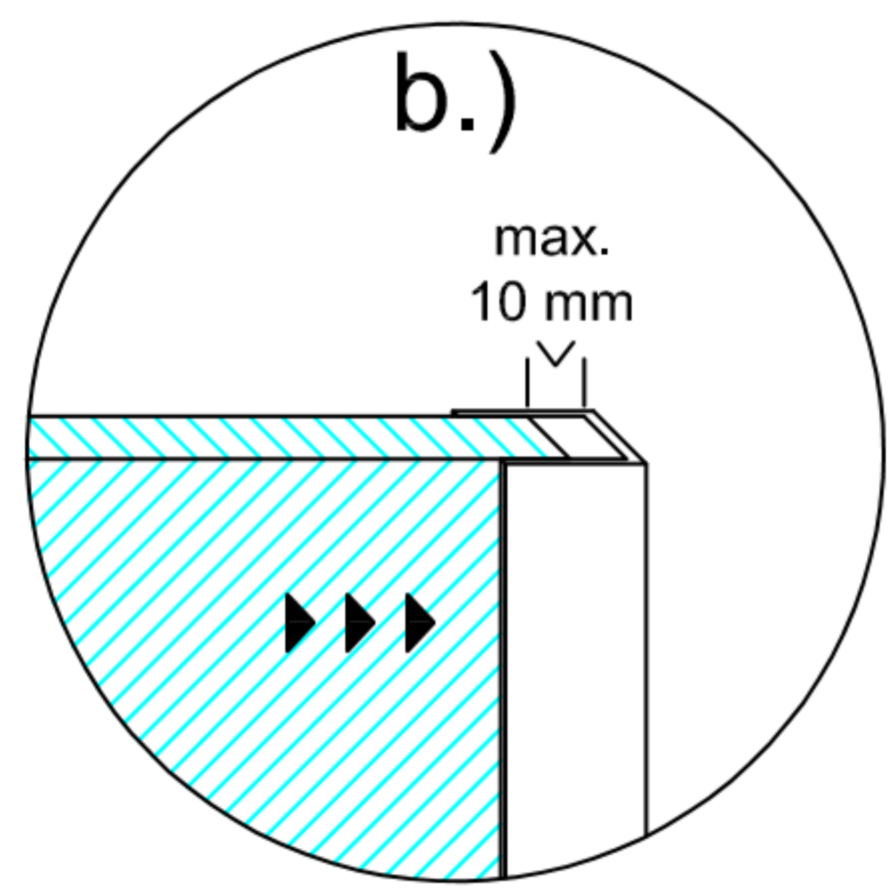
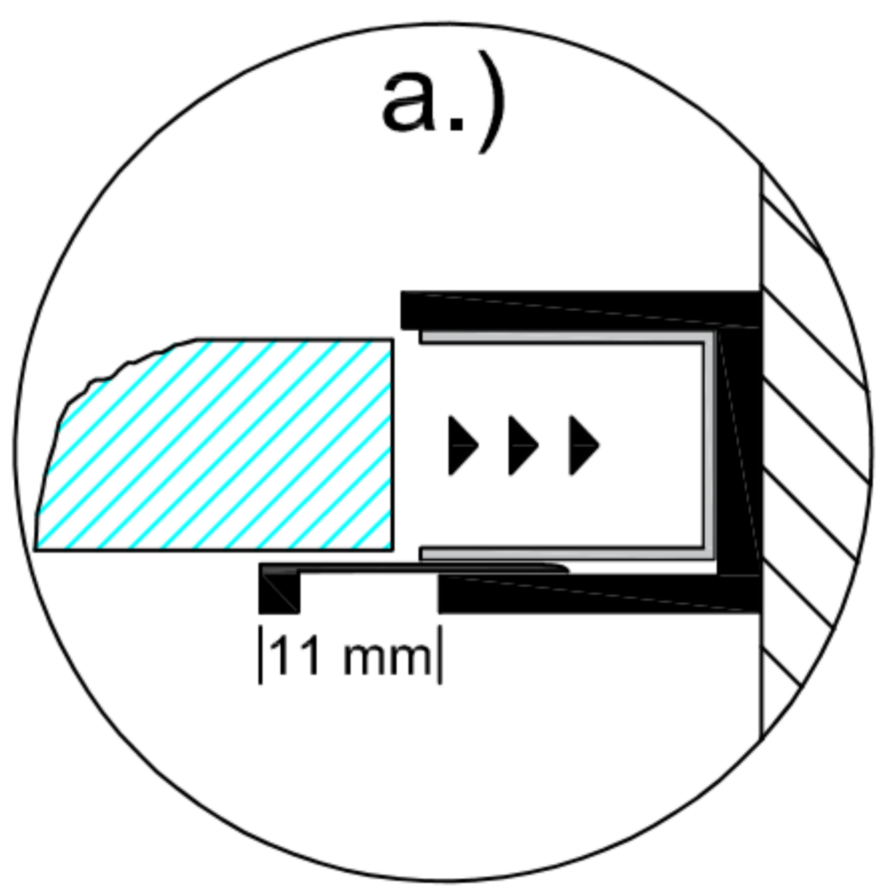
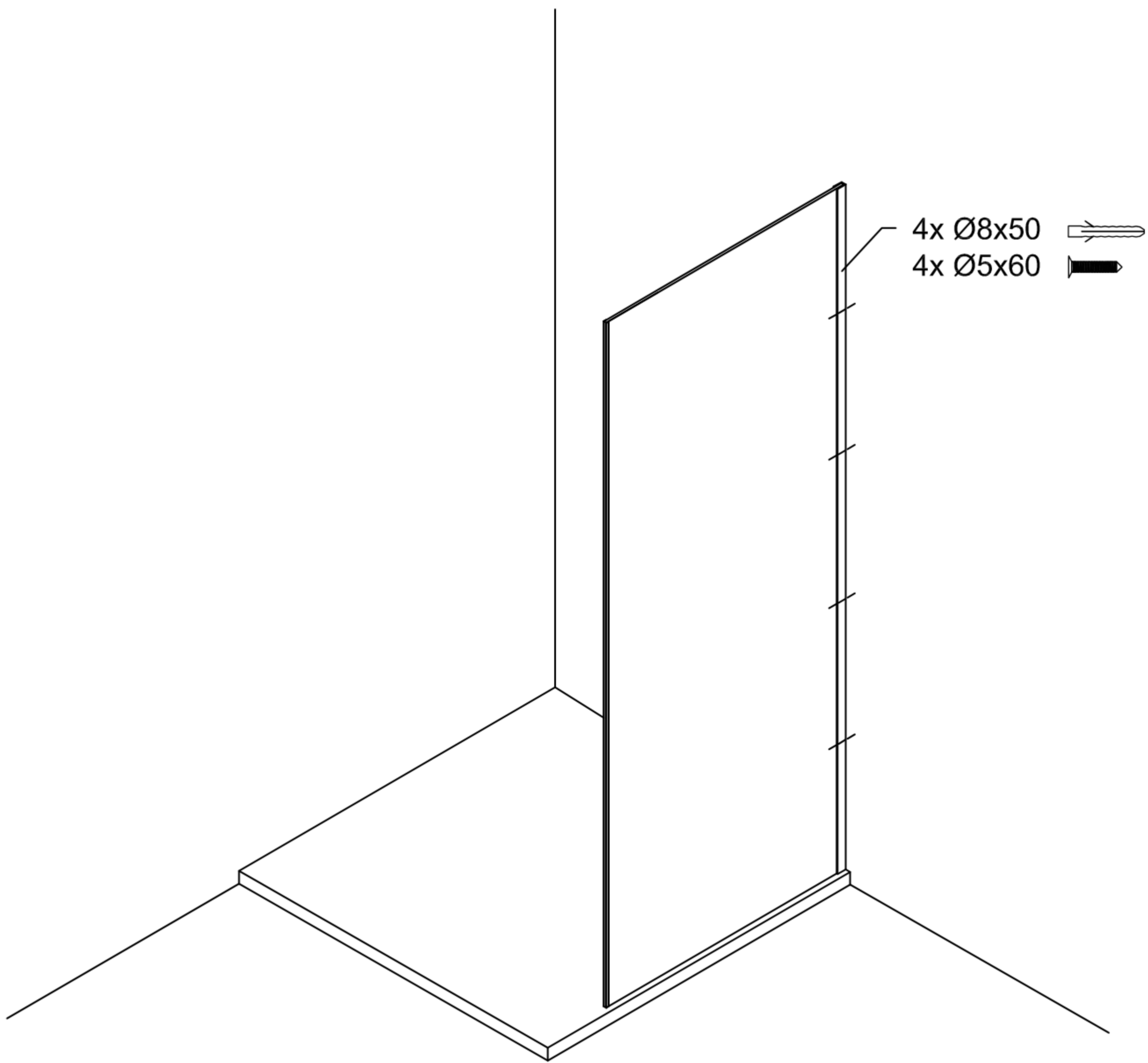

Wieder öffnen:
Open again:
Per riaprire:
Ouvrir à nouveau:

