

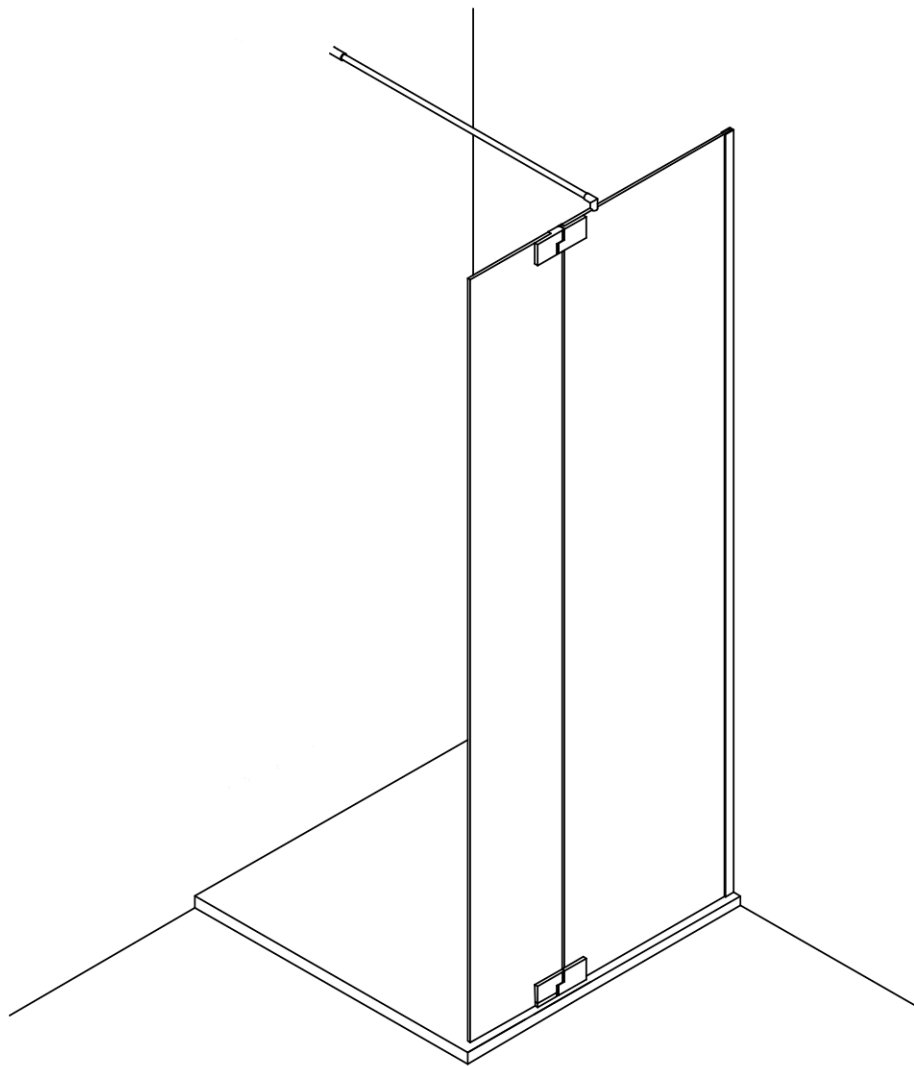















# Modell PGW2, PHW2, PMGW2

Montageanleitung  
Installation Manual



Eck-Dusche mit Festwand  
Corner shower enclosure with fixed side panel  
Rechts / Right

1 x G/GS-RO		1 x G8/G8H		4 x G100		4 x 5x60		1 x 
1 x G/GS-RU		1 x G10		4 x G300		4 x 8x50		1 x 
1 x P/WKP		1 x G/SUL120				4 x M6x12		4 x 
4 x d						2 x C2		

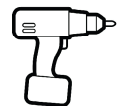
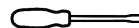
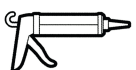
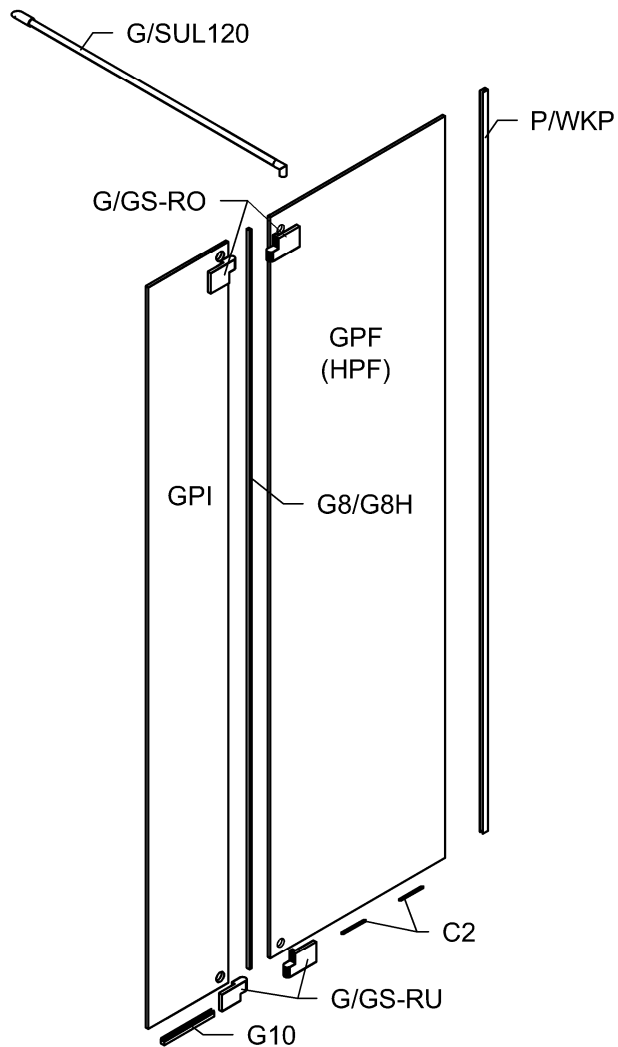

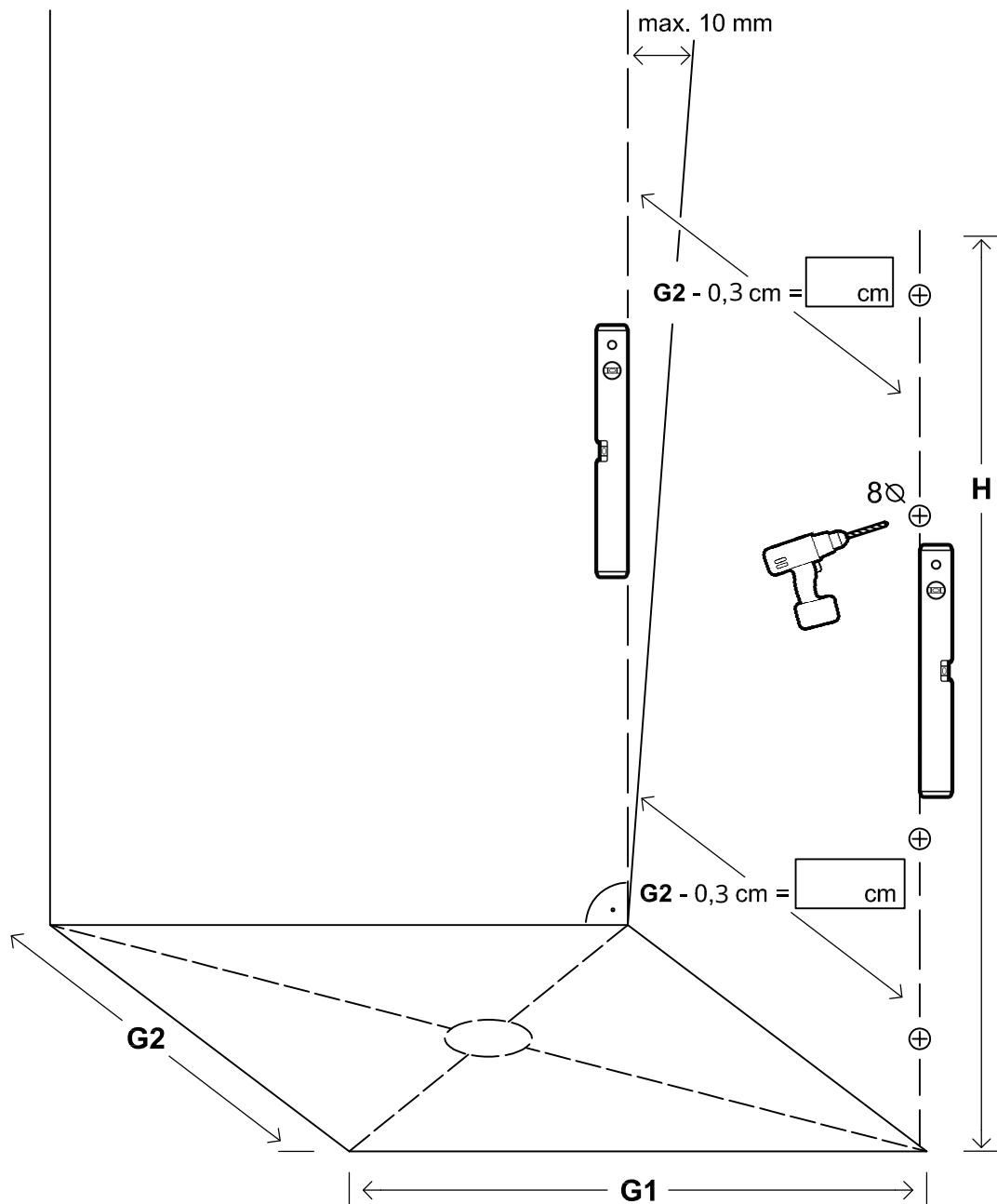

Benutzen Sie das Wandprofil in Glashöhe zum anzeichnen der Bohrlöcher.  
Use the wall profile in height of glass to mark the drill holes.

Diese Maße finden Sie in ihrem Auftrag:  
You find this measures in your order:

- H** = Glas - Höhe  
Glass height
- G1, G2** = Glasaußenkante (unterer Wert des Verstellbereichs)  
Outer edge of the glass (lower value of adjustment range)

Die Zeichnungen sind **nicht** Maßstabsgetreu.  
The drawings are **not** to scale.

# Vormontage von Dichtprofilen und Beschlägen Pre-assembly of gaskets and fittings.

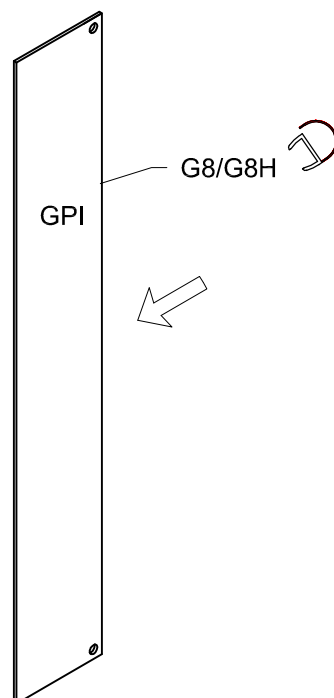
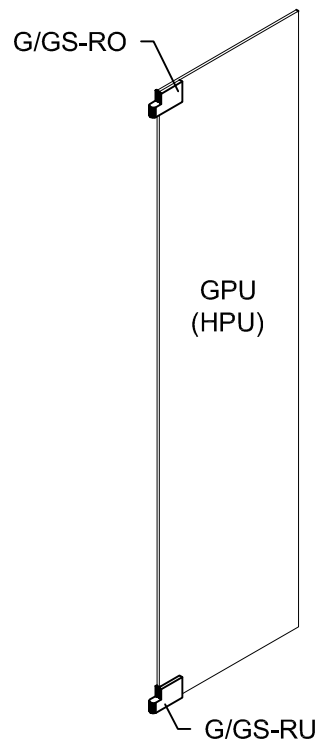

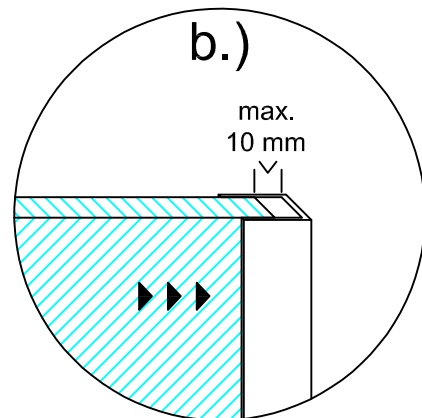
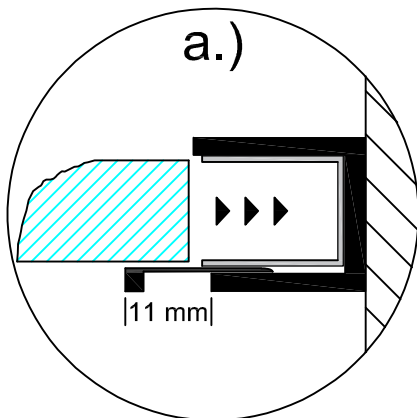
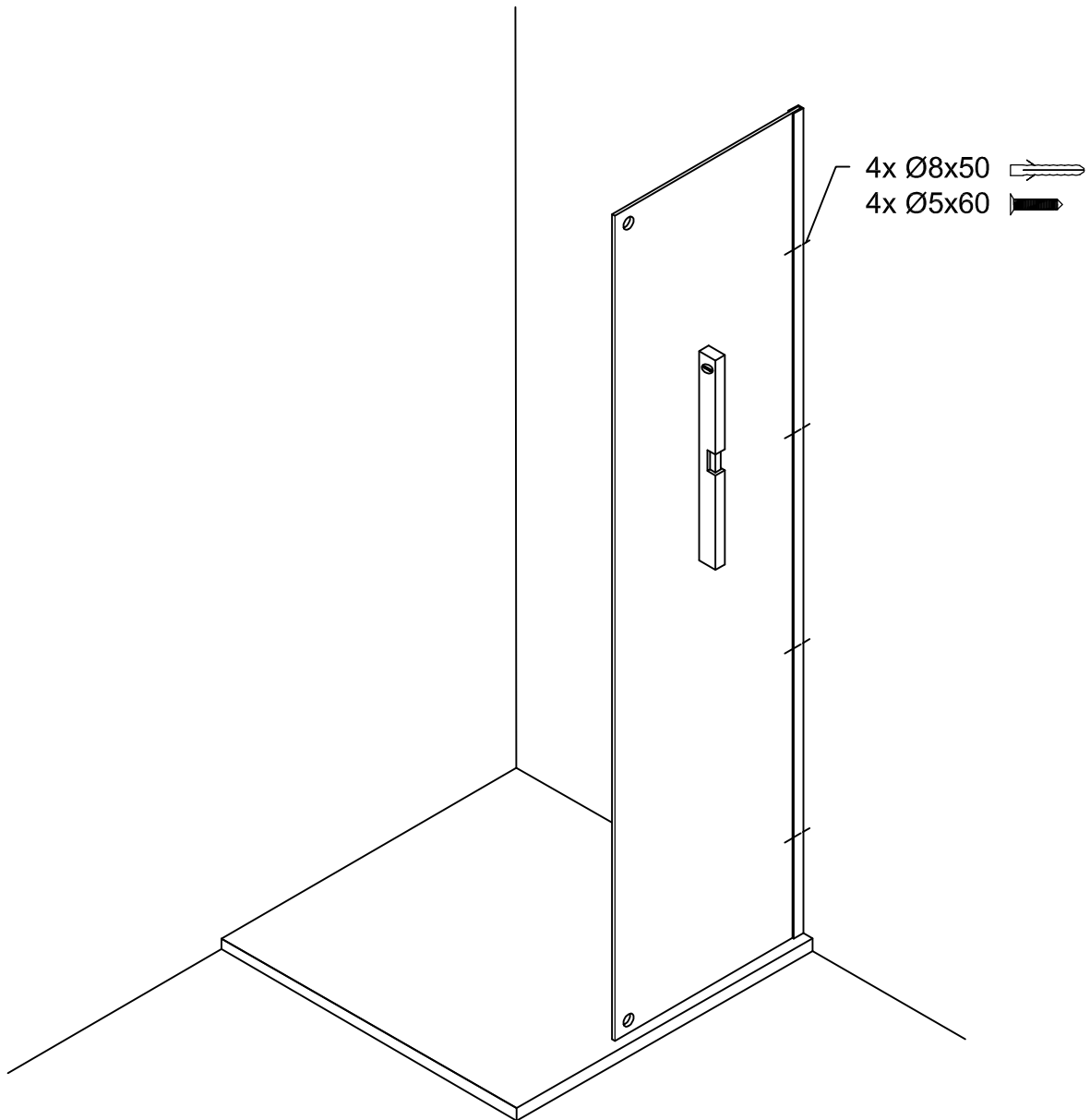

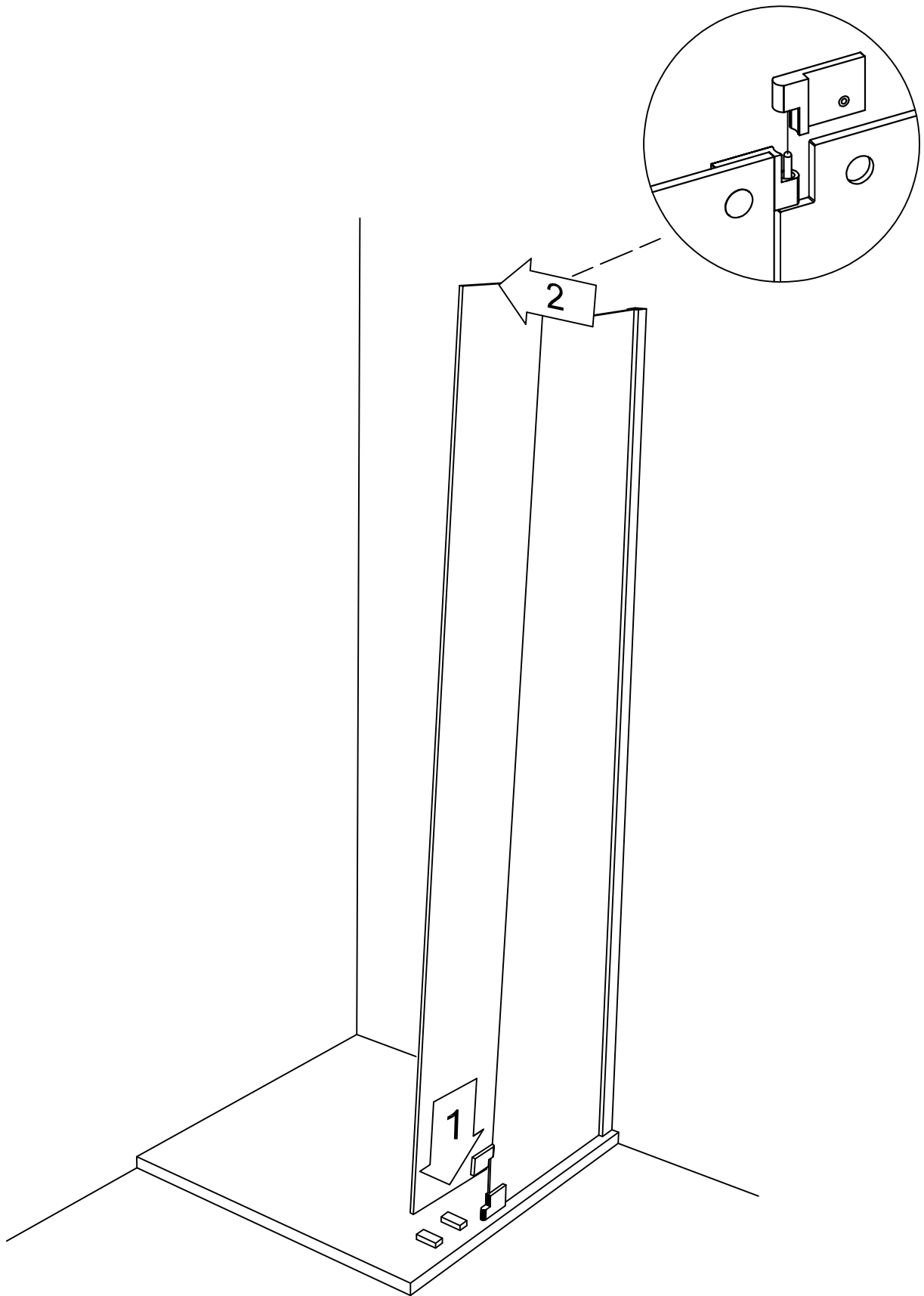

Wieder öffnen:  
Open again:  
Per riaprire:  
Ouvrir à nouveau:

