

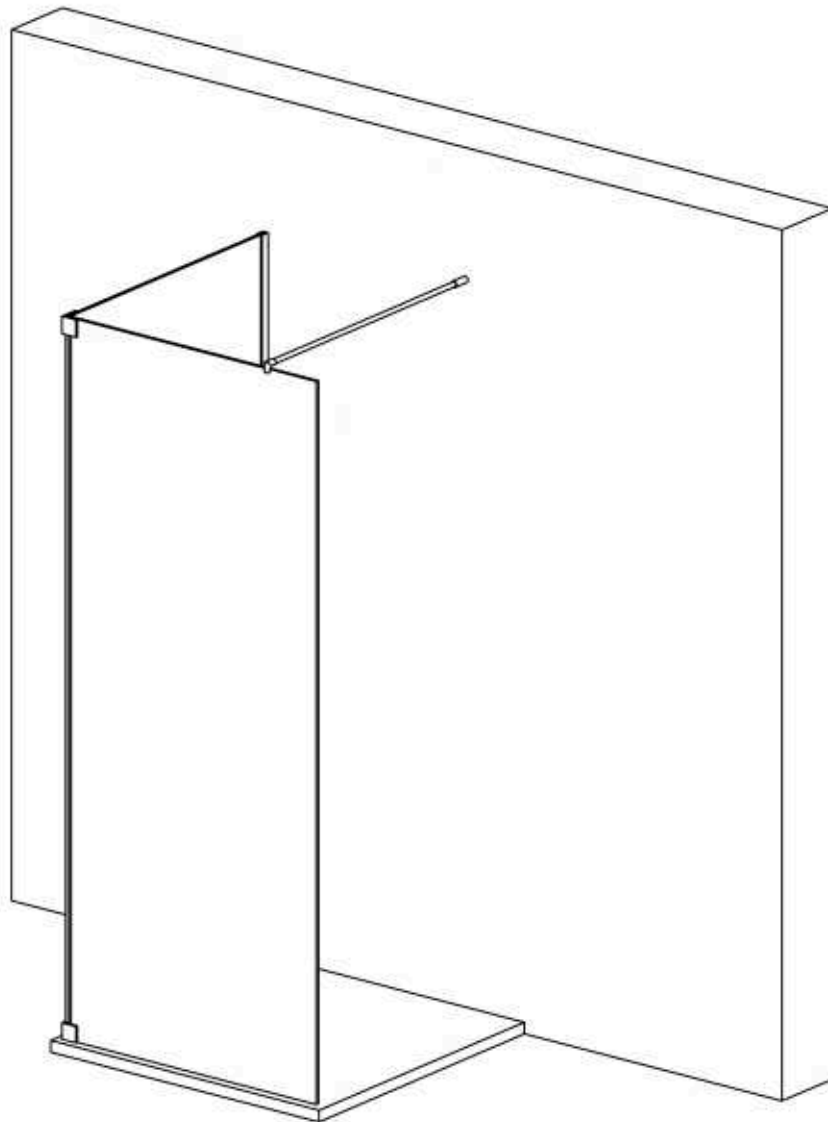













# Modell PGXW, PHXW, PMGXW

Montageanleitung  
Installation Manual



3-Seiten U-Duschkabine  
U-shaped shower enclosure  
Links / Left

- |           |   |            |   |   |   |   |   |   |   |
|-----------|---|------------|---|---|---|---|---|---|---|
| 2 x G/EL  |  | 1 x G9/G9H |  | 4 x G100  |  | 4 x 5x60  |  | 4 x C2  |  |
| 1 x P/WKP |  | 4 x d      |  | 4 x G300  |  | 4 x 8x50  |  | 1 x G/SUL120  |  |
|           |   |            |   | 1 x  |   | 4 x  | M6x12   | 1 x  |   |

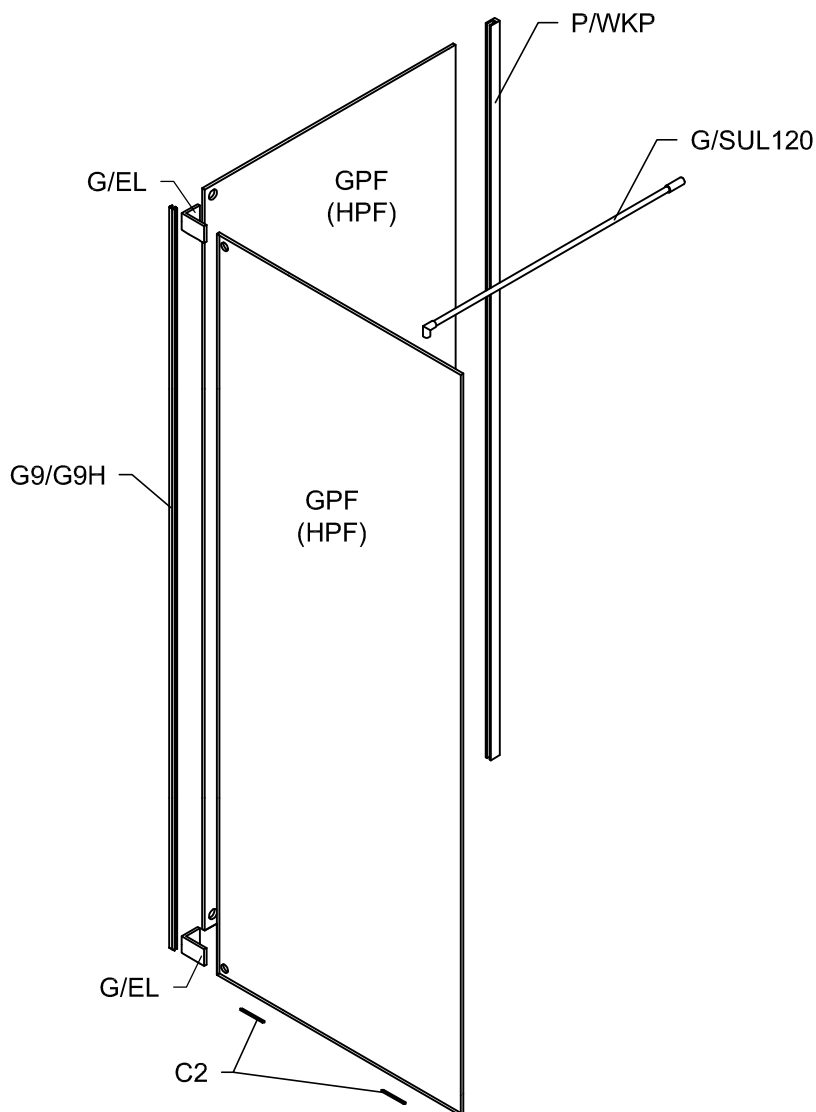

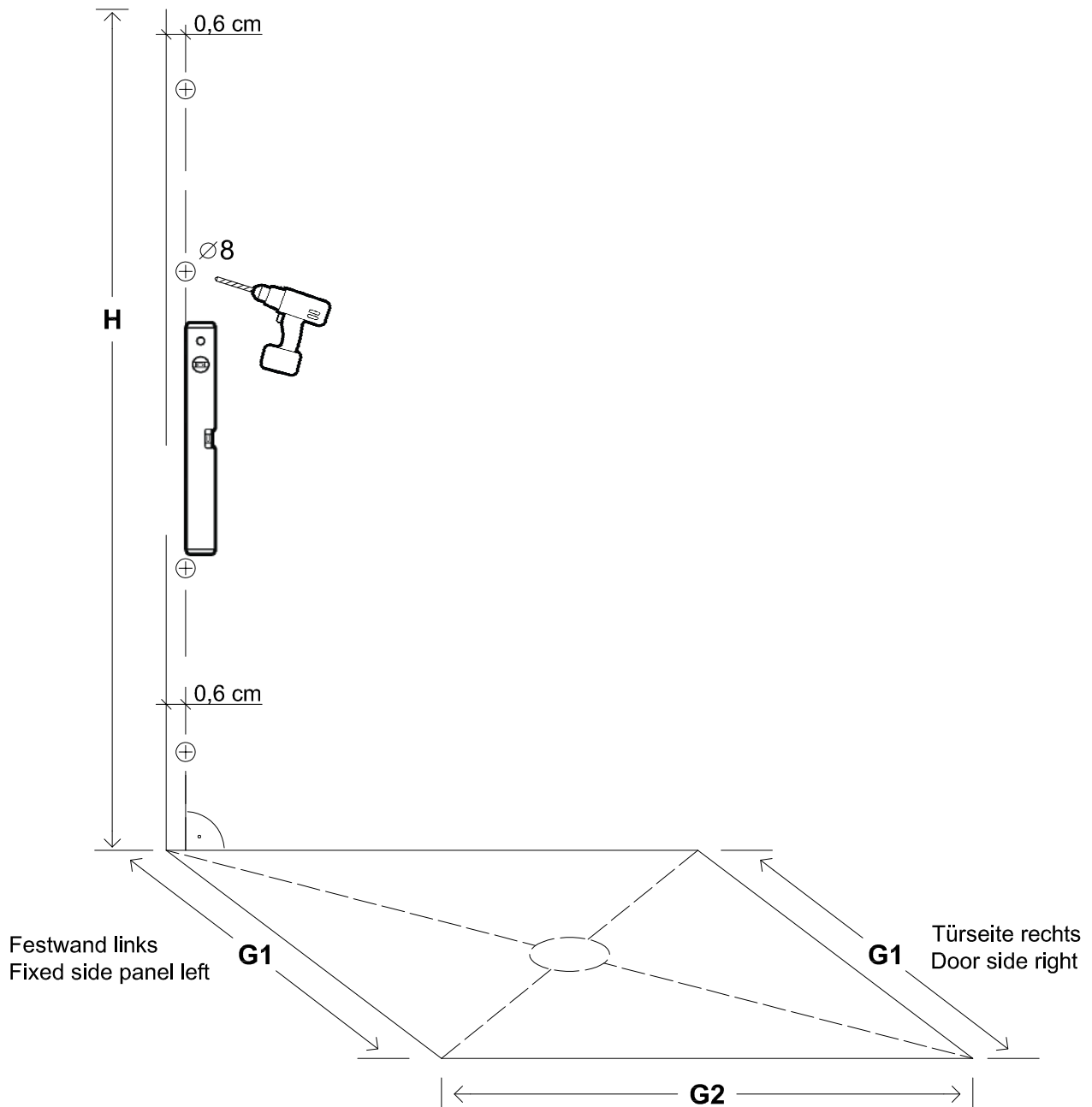

Benutzen Sie das Wandprofil in Glashöhe zum anzeichnen der Bohrlöcher.  
Use the wall profile in height of glass to mark the drill holes.

Diese Maße finden Sie in ihrem Auftrag:  
You find this measures in your order:

**H** = Glas - Höhe  
Glass height  
**G1, G2** = Glasaußenkante (unterer Wert des Verstellbereichs)  
Outer edge of the glass (lower value of adjustment range)

Die Zeichnungen sind **nicht** Maßstabsgetreu.  
The drawings are **not** to scale.

# Vormontage von Dichtprofilen und Beschlagen

## Pre-assembly of gaskets and fittings.

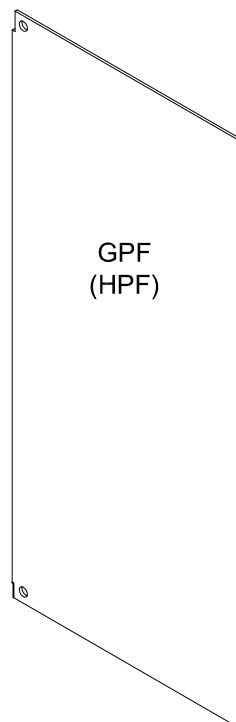
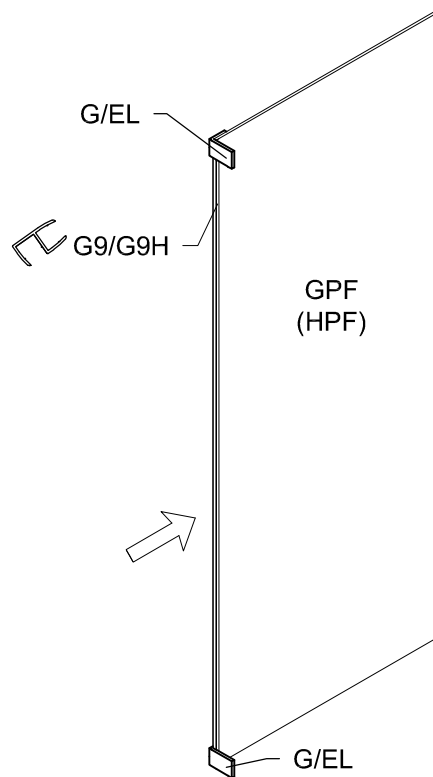

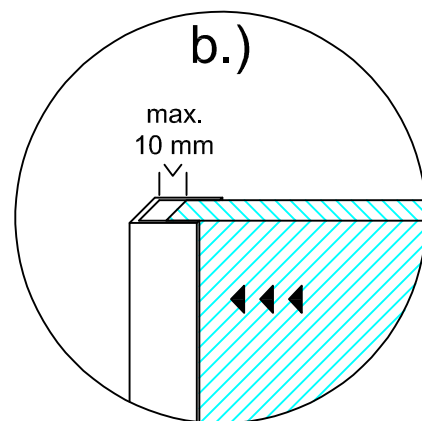
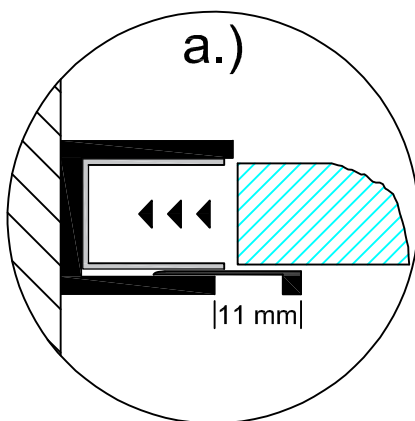
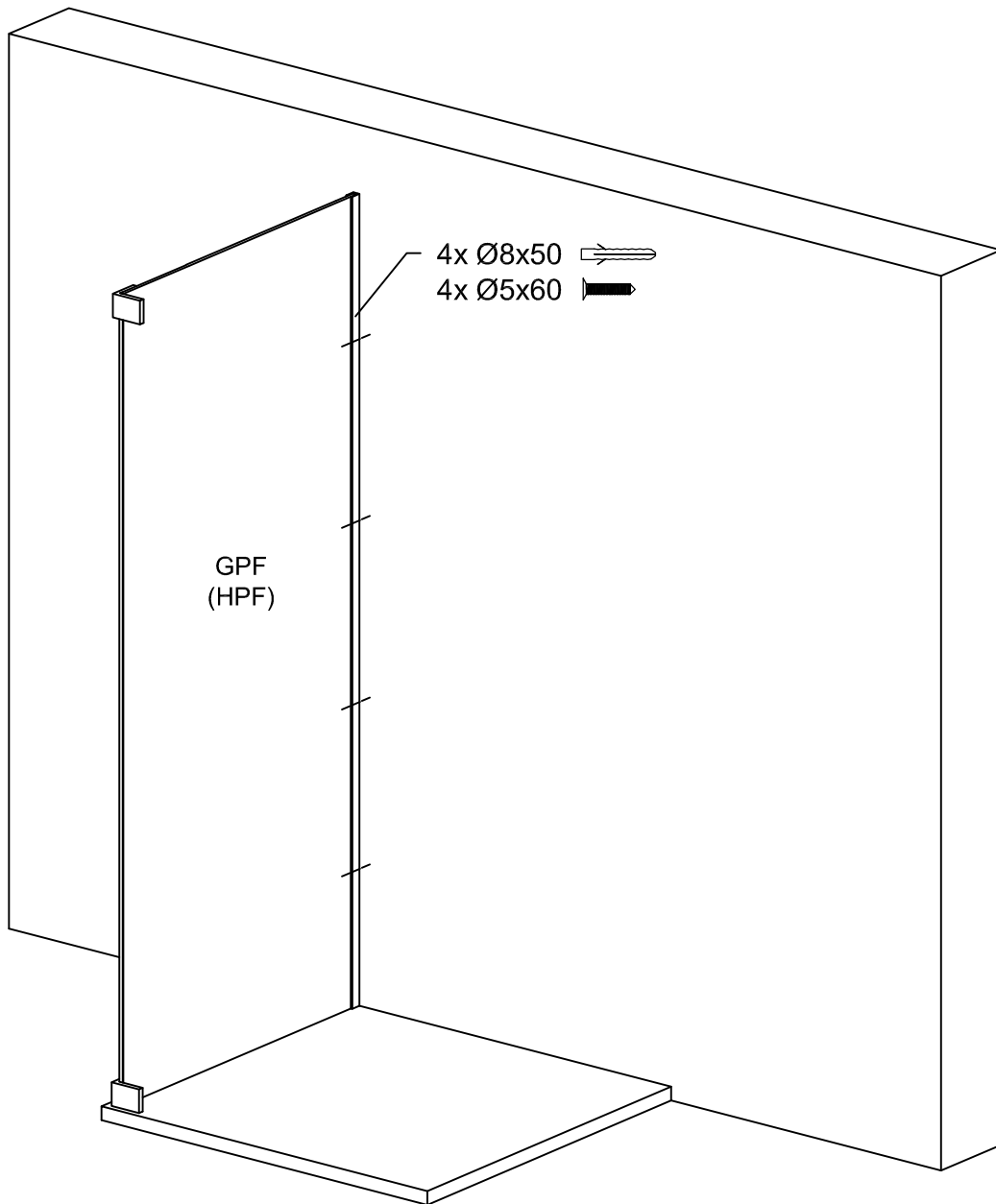

Wieder öffnen:  
Open again:  
Per riaprire:  
Ouvrir à nouveau:

